

Barton Convertible®

I-400 / I-700

(b1041-TS-GEL / b1071-TS-GEL)

Owner Operation Manual

(With Warranty) Rev B Feb '10

- This Operation Manual provides important instructions for the safe use of Barton Convertible® I-400/I-700 chairs. Please read this manual carefully and use Convertible® I-400/I-700 chairs only after you have developed a full understanding about their safe and correct use.
- Do not use the Convertible® without first reading and understanding the transfer procedures.
- Keep this manual where you can consult it whenever necessary.
- The information contained in this manual is subject to change without notice.



HUMAN CARE

Your Life. Your Way.

WARNING

Do not operate this equipment without first reading and understanding this manual. If you are unable to understand the warnings, cautions, and instructions, contact a healthcare professional, dealer, or technical personnel, if applicable, before attempting to use this equipment. Otherwise injury or damage may result.

SAVE THESE INSTRUCTIONS.

Indications for Use:

The Convertible® I-400 / I-700 I-Series Positioning and Transfer Chair is a mechanical positioning chair that can be adjusted to various positions. The device is used to alter postural positions and to provide a means of transferring a patient horizontally from a height adjustable bed or trolley, to the chair and vice versa. The chair can then be transformed from a supine position into the sitting position without ever lifting the patient.

Device Description

The Convertible® Positioning and Transfer Chair construction is made of steel tubular components, on to which is fitted foam filled upholstery. The mechanism allows the Convertible® Positioning and Transfer Chair to transform from the horizontal supine position into a chair, which can then be tilted. The reclining function allows the Chair and patient profile to change from a sitting position to a horizontal or supine position suitable for transferring. The Tilt-in-Space function allows the I-400 / I-700 to be independently inclined to the rear (Tilt-in-Space).

Contraindications

The Convertible® Positioning and Transfer Chair is not intended for patient transport in a moving vehicle of any type.

Only use The Barton Patient Transfer System with the Convertible® I-400 / I-700 Positioning and Transfer Chair.

The Convertible® Positioning and Transfer Chair is intended for indoor ambient environments. It is not intended for use in high moisture areas (i.e. showers, pool therapy), extreme temperature, humidity, or pressure environments.

Risks and Benefits

The decision to use the Convertible® Positioning & Transfer Chair must be made by a trained caregiver. In all cases this chair can only be articulated when the patient is attended.

The Convertible® Positioning & Transfer Chair is ideal for moving those patients who are unable to move themselves. The patient can be moved without the indignity, discomfort, and medical limitations of traditional mobile hoists.

The patient will always be supported either on the bed and/or the chair and is never suspended. Therefore the patient can be moved with reduced risk of injury to either patient or caregiver.

The Convertible® Positioning & Transfer Chair is easy to operate by trained personnel.

Device Expectations

The device is used to alter postural positions and to provide a means of transferring a patient horizontally from a height adjustable bed or trolley, to the chair and vice versa.

Environmental Issues

After life of the product:

- Recycle in accordance with the recycling codes of your country. Inquire at your local disposal management and recycling center for local codes.
- Recycle all metal parts.
- Plastic parts should be disposed of or recycled according to the directive in your country.

Contents

- Descriptive Information 1
- Contents..... 3
- 1 Part names 4
- 2 Safety notes 5
 - Warnings 6
 - Cautions..... 8
- 3 Making adjustments..... 9
 - Seat height adjustments 9
 - Height/depth/angle adjusting levers 11
 - Headrest 12
 - Footrest..... 14
 - Leg rest 15
- 4 Operating the Convertible® I-400 / I-700 16
 - Casters..... 16
 - Tilting operation 17
 - Side rails 20
 - Chair brackets..... 21
- 5 Troubleshooting the Convertible® I-400 / I-700 23
- 6 Maintaining the Convertible® I-400 / I-700 24
- 7 Specifications 26
- 8 Warranty and service..... 27
 - Limited warranty 28

1 Part names

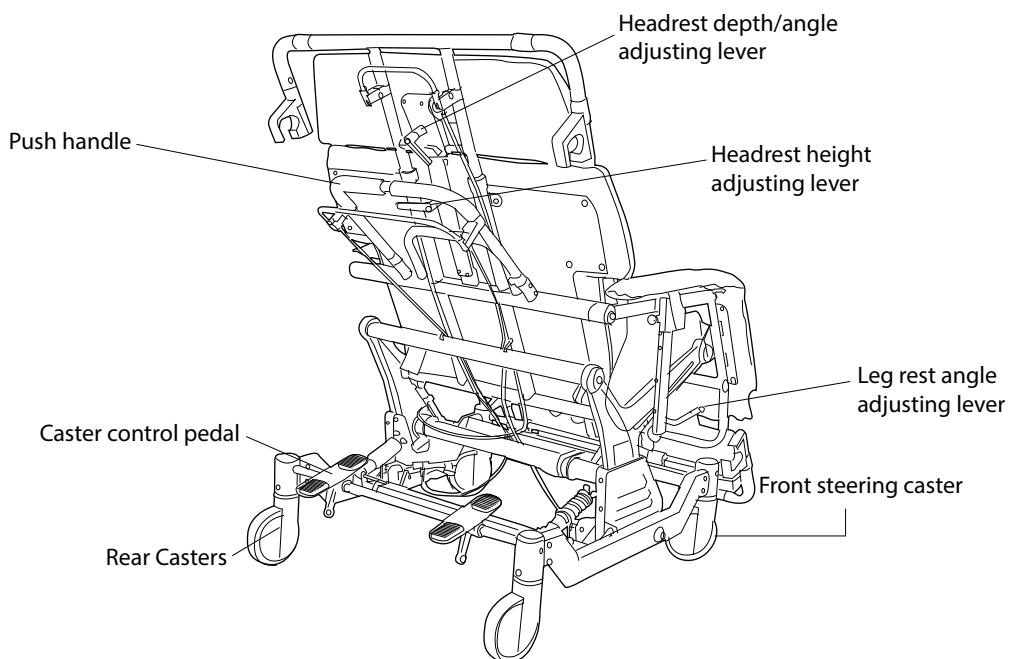
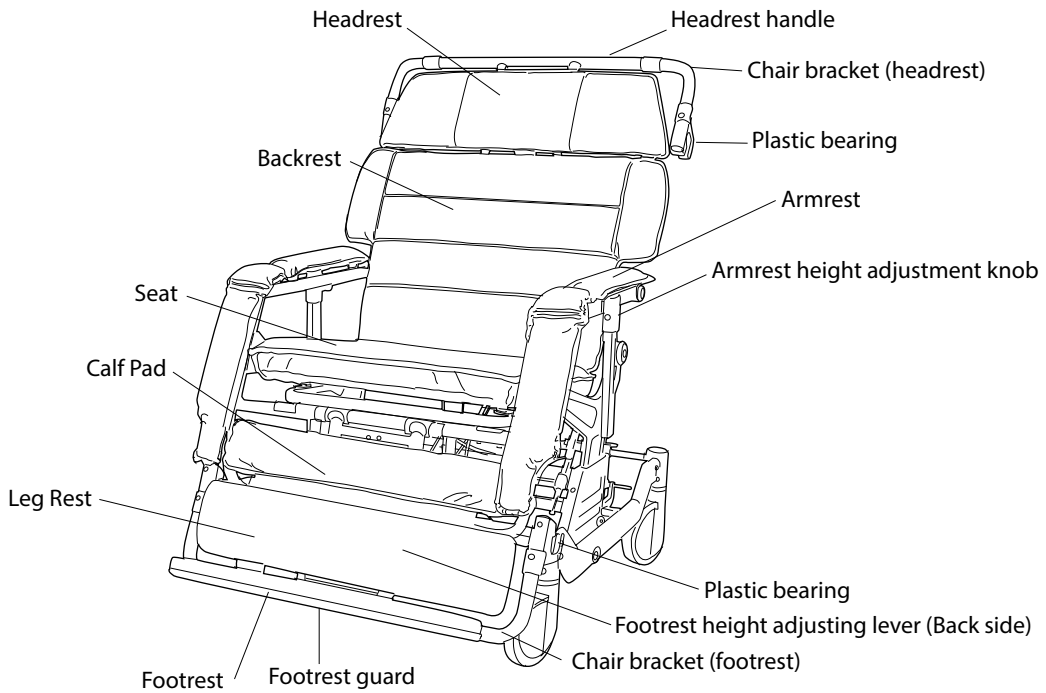

2 Safety notes

You must understand the warnings and cautions in this manual to use the Barton Convertible® safely. Please read all of these instructions carefully to avoid personal injury or property damage.

Tie-Down Restraints and Seat Positioning Straps

The Department of Transportation has not approved any tie-down system for transporting an occupied Convertible® in a moving vehicle of any type. The manufacturer does not recommend transporting the Convertible® in vehicles of any kind while the equipment is occupied.

It is the manufacturer's position that users of the Convertible® should be transferred to appropriate seating in vehicles and be transported with the use of standard auto industry restraints. The manufacturer cannot and does not recommend any transportation system for the Convertible®.

As regards to restraints and seat positioning straps, therapists and other healthcare professionals are obligated to determine if a seat positioning strap is required to ensure the safe operation of this equipment by the user. Serious injury can occur in the event of a fall from a Convertible® chair.

Weight Limitations

The maximum occupant weight for the Convertible® I-400 is 400 lb.

The maximum occupant weight for the Convertible® I-700 is 700 lb.

People who weigh more cannot use these models.

Some patients' physical limitations or weights present the potential for injuring an attendant or the patient when reclining the Convertible®.

When in doubt, ensure that additional attendants are present.

Before using the Convertible®, verify that:

1. All casters work properly (4-caster lock, 4-caster free, steering lock).
2. The equipment reclines smoothly and stops in any desired position.
3. The height and angle of the footrest and the height, angle, and depth of the headrest can be adjusted properly.
4. The side rails can be locked and released reliably.
5. The equipment tilt smoothly and stops in any desired position.
6. All height adjustment screws are securely tightened.

2 Safety notes (continued)



WARNING

Please heed the following warning. Failure to observe them can lead to an accident and can seriously injure the patient.

Warnings

- After any adjustment, repair, or service and before use, ensure that all attaching hardware is tightened securely.

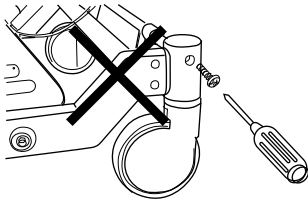

- Do not attempt to move the Convertible® in the fully reclined or nearly reclined position.

Do not move!

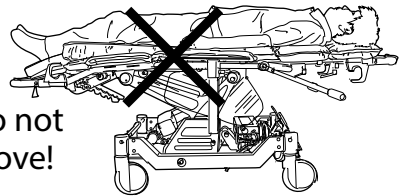

- Do not push or pull the Convertible® by the headrest handle.

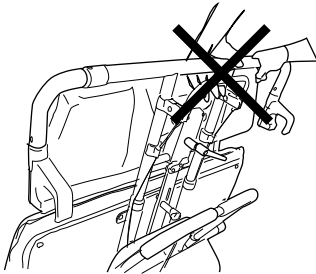

- To maintain maximum stability when reclining / inclining the Convertible®, position the patient with arms and legs inside the chair and clear of moving parts.

Inside Raised armrest

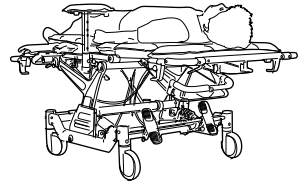

- Do not confuse the headrest and footrest when placing the patient in the prone position.

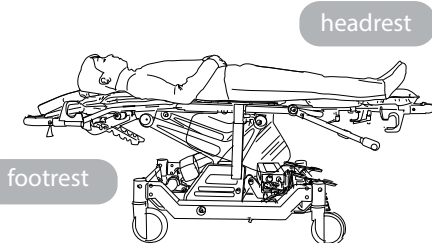

- Do not jump up and down on the back cushion or seat cushion.

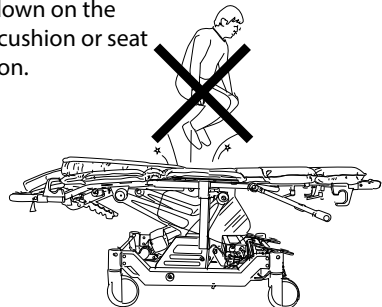

2 Safety notes (continued)

Warnings

- Do not use stairs or escalators to move an occupied Convertible® in any position.

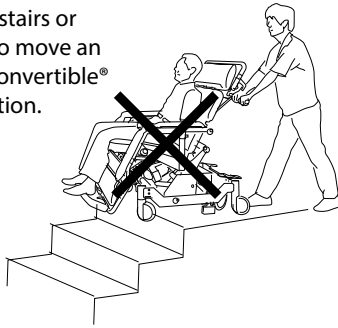

- Ensure that all persons and objects are clear of the Convertible® when you recline/incline the equipment.

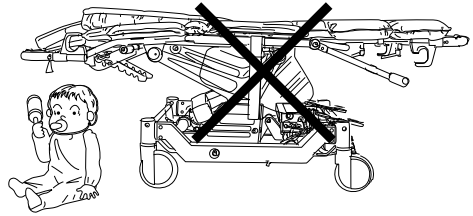

- Take special care to lock the casters securely.

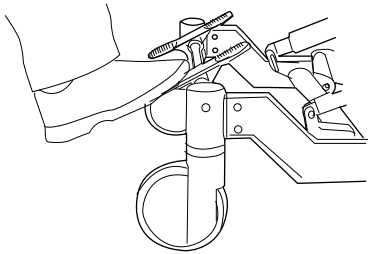

- Never disassemble or remodel the Convertible®.

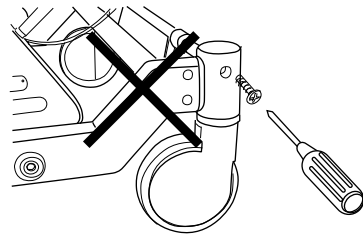

- Never sit or lean on the headrest or the legrest when the Convertible® is in the supine position.

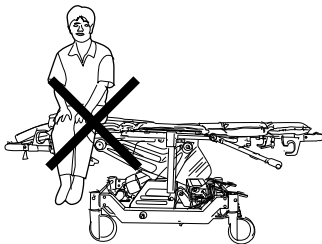

- Take special care when going up or down a ramp. Never park the Convertible® on a slope. Never leave an occupied chair unattended. Only operate chair on handicap grade access ramp.

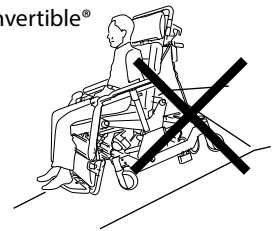

- The maximum occupant weight for the I-400 is 400 lb.
The maximum occupant weight for the I-700 is 700 lb.
People who weigh more cannot use these models.

- Do not attempt to lift the Convertible® I-400 / I-700 chairs by holding the leg rest assembly.

- The Convertible® is not designed to properly support a patient receiving CPR. This will change the center of gravity and may cause the equipment to tip over.

- Do not use the Convertible® on gravel, frozen roads, or any surface that is extremely slick or wet.

2 Safety notes (continued)

Cautions

Please heed the following cautions. Failure to observe them may result in personal injury or mechanical failure.

- Do not attempt to use the caster locks to stop the Convertible® in motion. These locks are not designed to be braking devices.

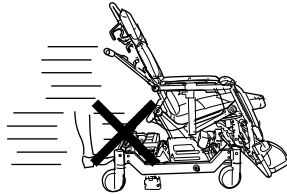

- Do not use the footrest as a step when you sit on or get off of the Convertible®.

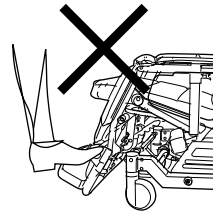

- Always raise the armrests whenever the patient is in the supine position. The armrests act as side rails.

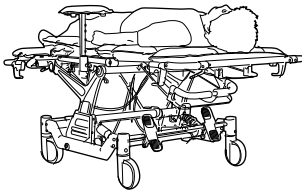

- Do not attempt to move the Convertible® by holding the armrest.

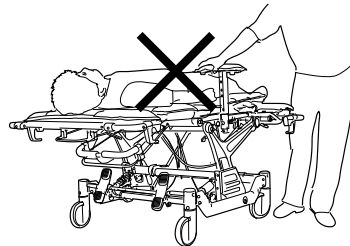

- The Convertible® is designed for a single occupant. Never allow two or more people nor place any other heavy object on it.



- Do not use near an open flame (stove, cigarette, etc.) or an extreme heat source.

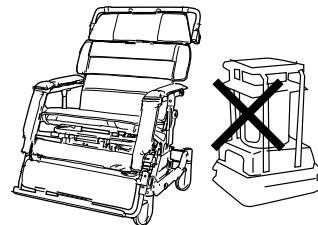

- Never apply any cutter or sharp-edged object to any of the cushions.

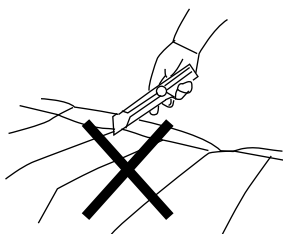

- The Convertible® I-400 / I-700 is not designed as a weight training or rehabilitation apparatus. Never use it for such purposes.

- Do not use a Convertible® with any missing or abnormal part.

- Use only parts, accessories, and adapters authorized by the manufacturer.

3 Making adjustments

Seat height adjustments

◆ Seat height is adjustable within 4 inches range

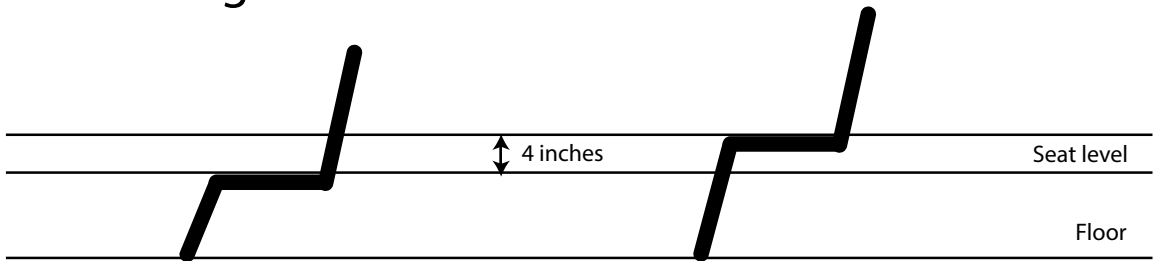

How to adjust

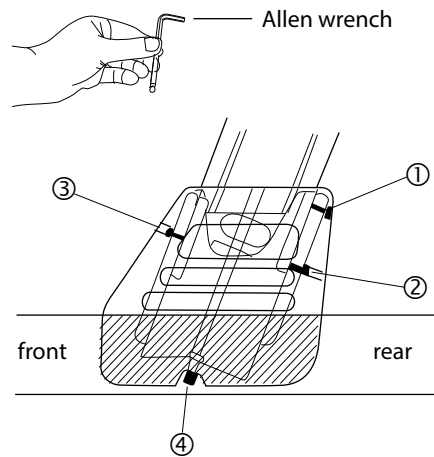
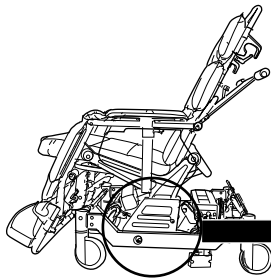

Raising the height

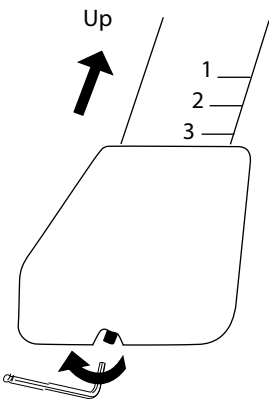

1. With Allen wrench (**5mm**), loosen 6 bolts ①②③ on height adjust diecasts on both left and right side of the Convertible®. Be careful not to unscrew the bolts.
2. Using the Allen wrench, rotate ④ bolt counterclockwise alternating between left & right sides at 1/2" increments.
3. Repeat 2 until the seat height reaches desired height.
4. Tighten bolts ① **and** ② on both sides.
5. After tightening ① **and** ②, **tighten bolt ③ on both sides.**



CAUTION

Do not set height above 4 inch mark.

3 Making adjustments (continued)

Lowering the height

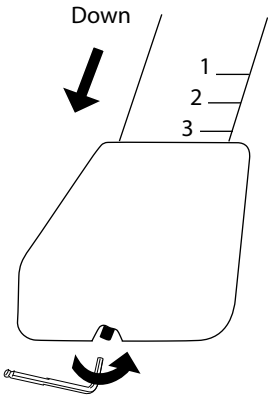

1. With Allen wrench (**5mm**), loosen 6 bolts ①②③ on height adjust diecasts on both left and right side of the Convertible®. Be careful not to unscrew the bolts.
2. Using the Allen wrench, rotate ④ bolt clockwise alternating between left & right sides at 1/2" increments.
3. Repeat 2 until the seat height reaches desired height.
4. Tighten bolts ① **and** ② on both sides.
5. After tightening ① **and** ②, **tighten bolt ③ on both sides.**



CAUTION

Make sure the bolts ①②③ on both left and right are fully tightened after raising height adjust of seat.

3 Making adjustments (continued)

Height/depth/angle adjusting levers

◆ The Convertible® I-400 / I-700 has three adjusting levers:

1. Headrest height adjusting lever
2. Headrest depth/angle adjusting lever
3. Footrest height adjusting lever

These three levers, which are in the same form, have two functions:

Function 1 Tighten and loosen. (Turn clockwise to tighten and counterclockwise to loosen.)

Function 2 Change lever position in a tightened state.



CAUTION

Do not change the lever position in a loosened state.

1. Turn the lever clockwise. When it is tightened, make the adjustment according to the instructions for the applicable lever.
2. To adjust the headrest depth/angle, push the headrest fully outward and then adjust as in 1 above.

Function 1 Tighten/Loosen

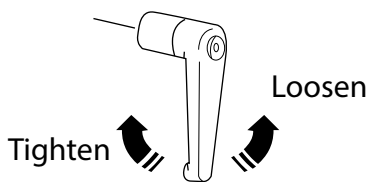

Function 2 Adjust lever position

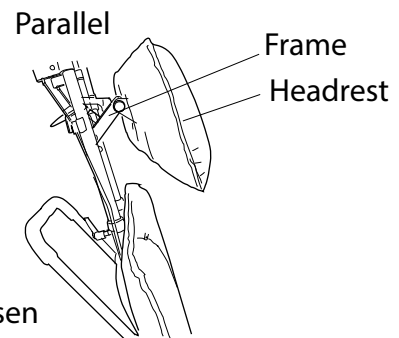
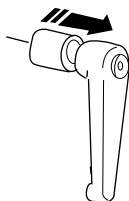

CAUTION

The lever position cannot be adjusted unless the lever is tightened.

3 Making adjustments (continued)

Headrest



WARNING

Always use both hands when raising or lowering headrest. Otherwise an injury or an accident may occur.

Raising the headrest

- Hold the headrest handle with one hand.
- Loosen the headrest height adjusting lever with the other hand. Raise the headrest slowly.
- When the headrest reaches the desired height, tighten the lever fully.
- ※ At the correct height, the patient's neck is visible.

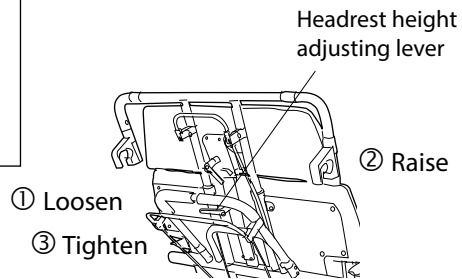

◆ Depth and angle adjustment

Loosen the lever

- Hold the headrest securely in one hand and loosen the headrest depth/angle adjusting lever by turning it counterclockwise.

Depth/Angle adjustment

- Position both the depth and angle of the headrest assembly while the adjusting lever is in its loose position.

Tighten the lever

- Once the depth and angle are correctly positioned, secure the headrest in place by turning the adjusting lever clockwise.

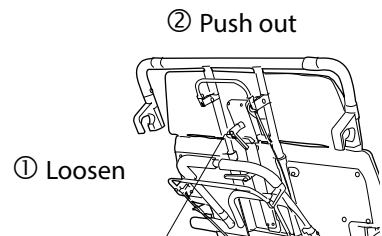

Headrest depth/angle adjusting lever

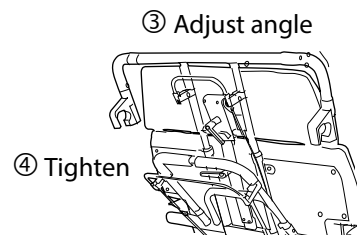

WARNING

When loosening the headrest depth/angle adjustment lever, be sure to hold the headrest securely in place. Loosening the lever with the headrest unsupported may cause the headrest to drop abruptly and an injury or accident may occur.

3 Making adjustments (continued)

◆ Support adjustment

Adjusting the headrest support

Hold the middle part of headrest support with one hand and turn one side at a time slowly inward with the other hand.

To return the headrest support to its original position, hold the middle part with one hand and pull one side at a time slowly outward with the other hand.

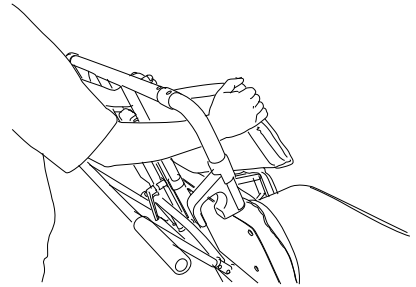

WARNING

When moving the headrest back to the home position, ensure that nothing comes between the headrest and the chair frame. Otherwise an injury or accident may occur.

◆ Returning headrest to original position

Loosen the lever

Hold the headrest securely in hand, so that it doesn't fall abruptly, and loosen the headrest depth/angle adjusting lever by turning it counterclockwise.

② Restore angle/depth to home position.

Depth/Angle adjustment back to original position

Position both the depth and angle of the headrest assembly while the adjusting lever is in its loose position.

Use both hands to move the headrest back to the original position.

① Loosen

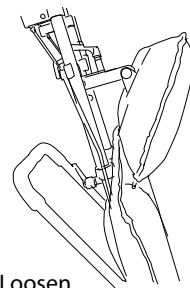

Tighten the lever

Once the depth and angle are correctly positioned, secure the headrest in place by turning the adjusting lever clockwise with your right hand while maintaining headrest position with your left hand.

③ Tighten

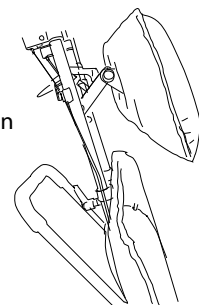

WARNING

When moving the lever back to home position, ensure that nothing comes between the headrest and the handle. Otherwise an injury or accident may occur.

3 Making adjustments (continued)

◆ Returning headrest to original position

Lowering the headrest

Hold the headrest handle with one hand. Loosen the headrest height adjusting lever with the other. Then lower the headrest slowly to its lowest position and tighten fully.



WARNING

Be sure to restore the headrest to the lowest position before transforming the Convertible to the supine position. Otherwise the patient's head can get caught between the back and the headrest, thus resulting in an injury or accident.

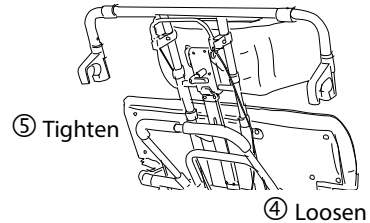

Footrest

◆ Positioning the footrest

Positioning the footrest for use

Use the footrest only at 0 degrees (in the supine position) and 90 degrees (in the upright position).



WARNING

Never use the footrest at any angle between 0 degrees and 90 degrees. Otherwise the footrest may suddenly fold or rise and cause an injury or accident.

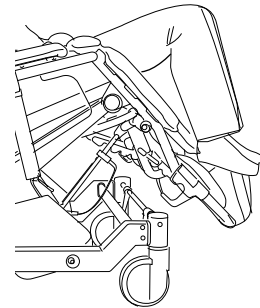

◆ Adjusting the footrest height

When raising and lowering

Hold the footrest guard handle with one hand and loosen the footrest height adjusting lever with the other. Then raise or lower the footrest slowly. When it reaches the desired height, tighten the lever fully.

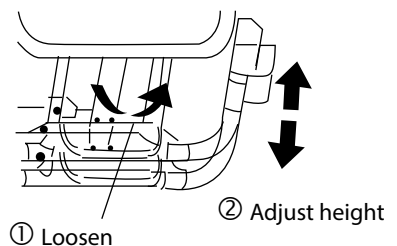

WARNING

Always use both hands when raising or lowering the footrest. Otherwise an injury or accident may occur.

3 Making adjustments (continued)

◆ Adjusting the footrest height



CAUTION

Position the footrest using the footrest height adjusting lever as shown at right. With the lever up, the leg rest may not be adjusted properly.

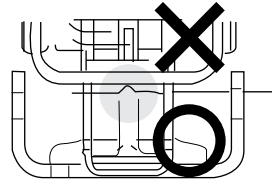

Leg rest

◆ Adjusting the angle of the leg rest

Raising the leg rest

Hold the footrest guard handle with one hand.

Raise the leg rest slowly by holding and pulling the leg rest angle adjusting lever and guard handle together with the other hand.

Release the leg rest angle adjusting lever when the leg rest reaches the desired position.

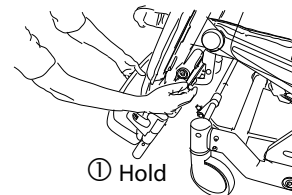

Lowering the leg rest

Hold the footrest guard handle with one hand.

Lower the leg rest slowly until it stops moving by holding and pulling the leg rest angle adjusting lever and guard handle together with the other hand.

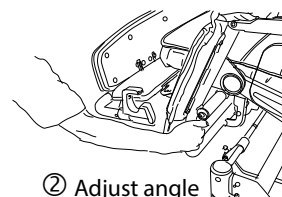

WARNING

Always use both hands when raising or lowering the leg rest.



CAUTION

Do not snap the lever; snapping may lead to mechanical problems.

4 Operating the Convertible® I-400 / I-700

Leg rest

The casters can be easily controlled by operating the caster control pedal.

◆ Central Lock

Function 1 4-caster lock function

Use this function to hold the Convertible® motionless when transforming it from a supine to an upright position and when transferring a patient to and from a bed.



CAUTION

The caster lock is not designed to stop the Convertible® in motion. Do not operate the caster control pedal while moving the equipment.

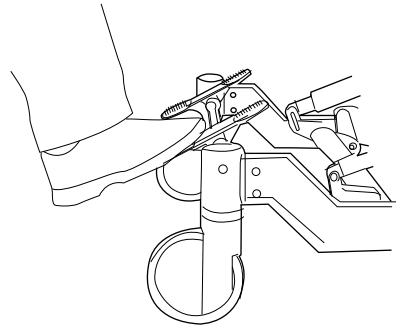

Function 2 4-caster free function

Use this function to bring the Convertible® alongside a bed or to "freewheel." This function allows all 4 wheels to swivel and rotate freely.

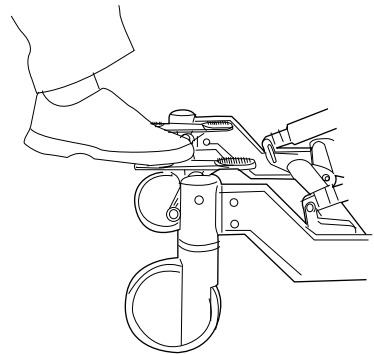

Function 3 Steering lock function

Use this function to lock the two front casters from swiveling so that the Convertible® can be easily steered in a straight line.



CAUTION

Only the two front casters have all three functions. Depress the caster control pedal as shown at right and move the Convertible® about three feet backward or forward. This will lock the swivel of the two front casters. You will then be able to move the equipment with greater stability.

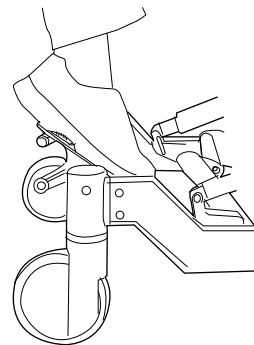

4 Operating the Convertible® I-400 / I-700 (continued)

Tilting operation (tilting down)

1. Hold the headrest handle with one hand and squeeze the tilting lever and push handle together with with other. Push both slowly downward.



WARNING

Always use both hands when pushing downward.

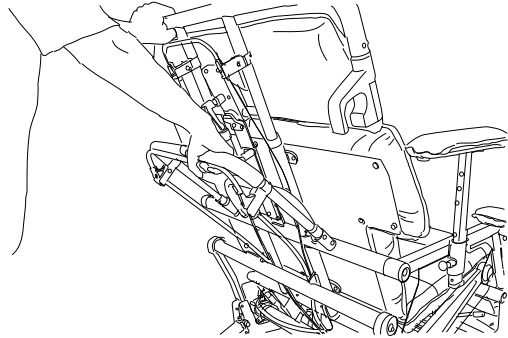

2. Release the tilting lever when the tilting reaches the desired angle.



CAUTION

Do not snap the lever, snapping may lead to mechanical problems.

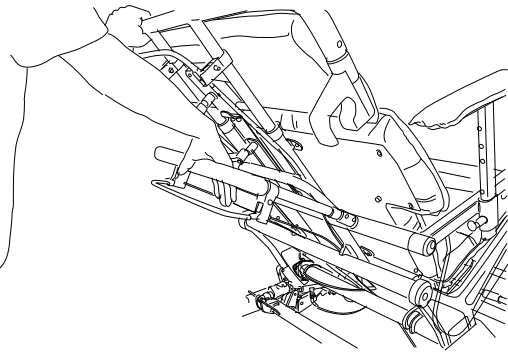

Tilting operation (tilting up)

1. Hold the headrest handle with one hand and squeeze the tilting lever and push handle together with other. Lift slowly upward.



WARNING

Always use both hands when lifting.

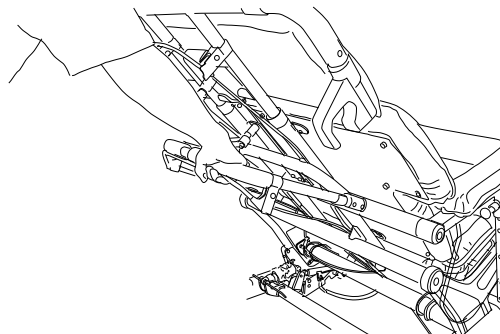

4 Operating the Convertible® I-400 / I-700 (continued)

2. Release the tilting lever when the tilting reaches the desired angle.

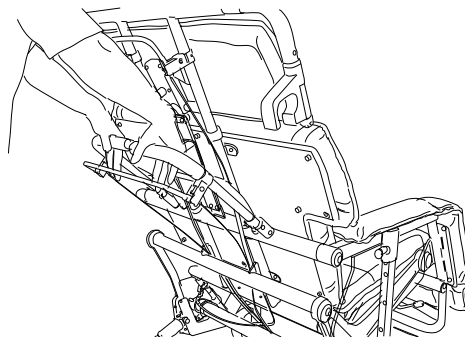

CAUTION

Do not snap the lever, snapping may lead to mechanical problems.

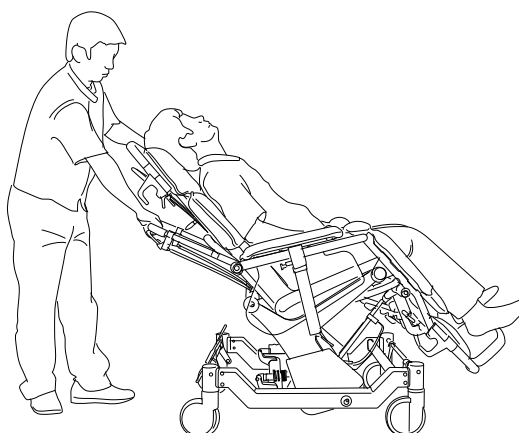
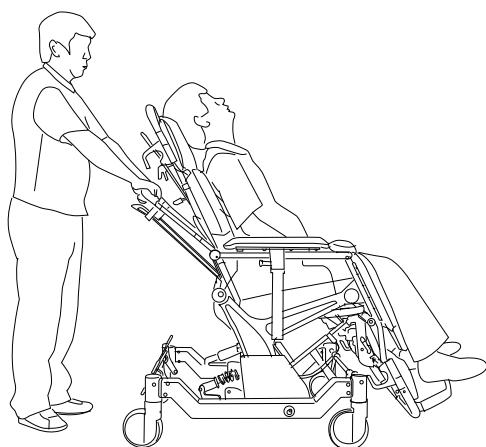

4 Operating the Convertible® I-400 / I-700 (continued)

◆ Changing from sitting to supine position

1. Hold the headrest handle with one hand and squeeze the reclining lever and headrest handle together with the other. Push both slowly downward.



WARNING

Always use both hands when pushing downward.

2. Release the reclining lever when the back reaches the desired angle.



CAUTION

Do not snap the lever; snapping may lead to mechanical problems.

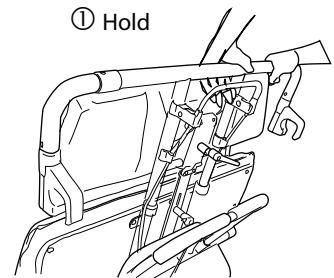

② Push down

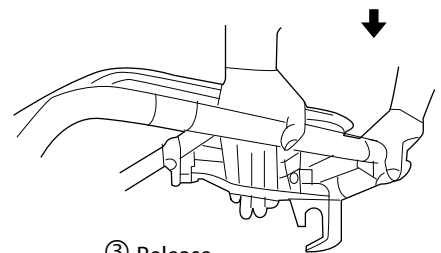

③ Release

◆ Changing from supine to sitting position

※ This reverses the procedure for changing from sitting to supine position.

1. Hold the headrest handle with one hand and squeeze the reclining lever and headrest handle together with the other. Lift slowly upward.



WARNING

Always use both hands when lifting.

2. Release the reclining lever when the back reaches the desired angle.

② Lift

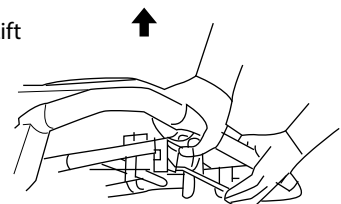

① Hold

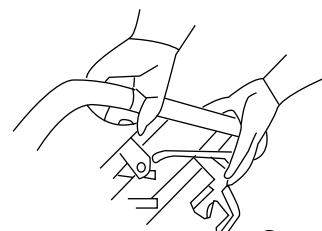

③ Release



CAUTION

Do not snap the lever; snapping may lead to mechanical problems.

4 Operating the Convertible® I-400 / I-700 (continued)

◆ Changing from supine to sitting position

3. Back adjustment angles can range between the supine position and 70 degrees.

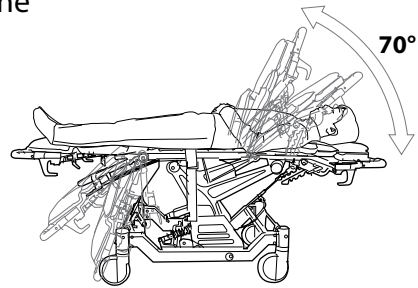

Armrests

◆ How to use the armrests as siderails

Raising the armrests

Pull the armrest height adjusting knob with one hand while simultaneously raising the armrest with the other. Once the side armrest is at the desired height, release the height adjusting knob and armrest will lock into place.

Raising side rails

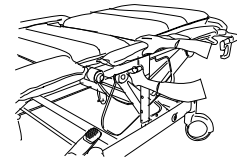

Lowering side rails

Lowering the armrests

Pull the armrest height adjusting knob with one hand while simultaneously lowering the armrest with the other.

Once the armrest is at the desired height, release the height adjusting knob and the armrest will lock into place.

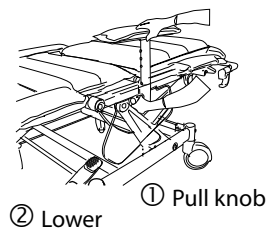

WARNING

Ensure that armrests are securely locked in place. An unsecured armrest may fall abruptly and an injury or accident may occur.

4 Operating the Convertible® I-400 / I-700 (continued)

Chair brackets

◆ Notes on chair brackets

The chair brackets are installed on each side of the headrest and footrest of the Convertible®.



WARNING

Use the chair brackets only when the Convertible® is in the supine position. Protruding chair brackets present a great danger; people and objects may get caught on them. After transferring a patient, be sure to restore the chair brackets to their original positions before transforming the equipment to the upright position.



CAUTION

Use the chair brackets only when transferring the patient using the transfer bar. Otherwise mechanical failure may result.

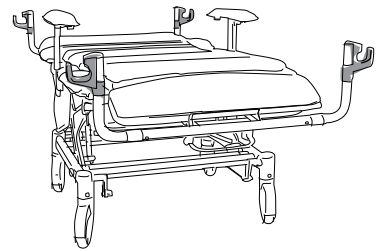

◆ Notes on chair brackets

Bringing alongside the bed

Bring the supine Convertible® alongside the bed and lock the casters.



① While pulling

Setting chair brackets for patient transfer

Hold the chair bracket opposite the bed side with one hand and the plastic ring on the guard handle with the other hand. Then turn the chair bracket 90 degrees while pulling the guard handle longitudinally to raise the chair bracket upright.

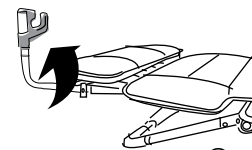

② Turn 90° upward

4 Operating the Convertible® I-400 / I-700 (continued)

◆ Use of chair brackets

Setting chair brackets for patient transfer (continued)

Now hold the upright chair bracket with one hand and the plastic bearing with the other. Pull and twist the chair bracket away from the bed and release it.

- ※ Perform this operation for both the headrest and footrest chair brackets on the side opposite the bed.

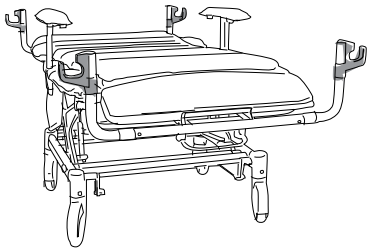

Correct orientation of chair bracket for patient transfer.

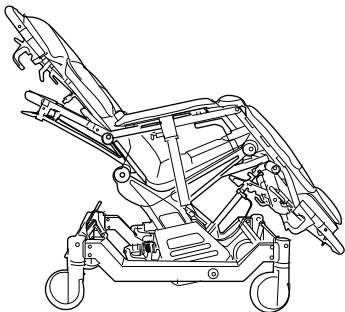

Correct orientation of chair bracket when chair brackets are not in use.

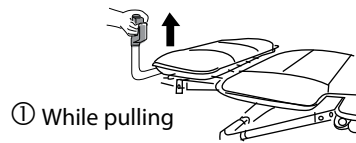

① While pulling

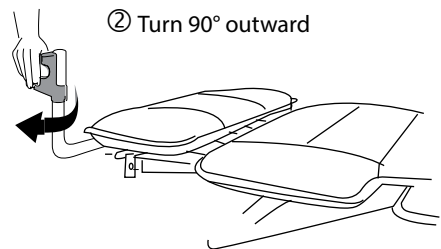

② Turn 90° outward



CAUTION

When restoring the chair brackets to their original positions, always ensure that the plastic bearings are down.

5 Troubleshooting the Convertible® I-400 / I-700

◆ Trouble? First make these checks.

Before contacting your dealer for repair, please make the following checks:

Trouble	Check	Correction	Page
Does not move	Caster lock	Release caster lock.	16
Does not go straight	Position of caster control pedal	Use the steering lock function of casters.	16
Headrest not locked	Lever position	Correct lever position.	12-14
Angle of leg rest not adjusted	Lever position	Correct lever position.	15

6 Maintaining the Convertible® I-400 / I-700

Checks and maintenance

1. Checks

Barton Convertible® chairs are designed for enhanced safety and durability. Yet they are not totally free from wear and tear resulting from environmental conditions, duration of use, and rough handling. For increased product longevity, periodically inspect all parts and replace them as needed.

2. Maintenance

Moisture can cause rusting and noise. Take care to wipe o any moisture present on the Convertible®.

◆ Cleaning the Convertible® I-400 / I-700



WARNING

Before using any cleaning product, test it on an inconspicuous area of fabric. Never use any volatile uid (thinner, gasoline, etc.) that could cause discoloration or deterioration.

WARNING: Gloves and protective clothing should always be worn when carrying out cleaning procedures.

All surfaces can be cleaned by wiping with a disposable cloth moistened with hand hot water and a neutral detergent. Rinse using clean water, dry with paper towels. When used by a patient known or suspected of having an infection this piece of equipment should be disinfected. After washing, wipe over with Sodium Dichloroisocyanurate (NaDCC) at 1,000 ppm of available chlorine (or other chlorine releasing agent). Alternatively wipe over with a 70% Isopropyl Alcohol wipe.

Cautions

- Do not use Hypocarbonate or Phenol based cleaning agents
- Do not use any volatile liquids such as thinners or petroleum
- The chair must not be pressure washed
- Do not use abrasive compounds or pads
- Tests show undiluted Dettol may damage paint and plastic parts if prolong contact is allowed

6 Maintaining the Convertible® I-400 / I-700

Fabric Cleaning Recommendations

WARNING:

- Gloves and protective clothing should always be worn when carrying out cleaning procedures.
- Before using any cleaning product, test it on an inconspicuous area of fabric. Never use any volatile uid (thinner, gasoline, etc.) that could cause discoloration or deterioration.

Cleaning:

- Do not use harsh cleaners or solvents
- Wipe fabric clean with neutral detergent and lukewarm water or with a sodium hypochlorite solution (0.1% or 1000 ppm available chlorine). Rinse thoroughly and allow drying before return to service.
- To control or prevent odor on long term incontinent applications, clean daily.

Disinfection:

- Most phenolic or quaternary type disinfectants can be used. User must dilute disinfectants and germicides in accordance with manufacturer's instructions.
- Iodophor type disinfectants (i.e. Betadine) will stain fabric.

7 Specifications

Product name		BARTON Patient Transfer System	
Model:		I-400	I-700
Maximum occupant weight:		400 lb	700 lb
	Overall length (max)	Fully reclined with headrest and footrest fully extended: 84 in	
	Overall length (min)	Fully reclined with headrest and footrest not extended: 74 in	
	Overall height (max)	Fully upright at highest headrest position: 61 in	
		Fully reclined: 31.25 in	
	Overall height (min)	Fully upright at lowest headrest position: 52 in	
		Fully reclined: 27.25 in	
	Overall depth	Fully upright with footrest down: 47.5 in	
	Overall width	29.5 in	35 in
	Seat width	21 in	25 in
	Seat depth	19 in	19 in
	Net weight	191 lb	206 lb
	Shipping weight	215 lb	235 lb
	Back angle	0° to 70°	
	Tilting angle	0° to 17°	
Headrest adjustable height	0 to 5 in		
Footrest adjustable height	0 to 5 in		
Materials	Caster	6 in diameter	
	Frame	Steel tubing, aluminum	
	Cushion	Polyurethane coated fabric Urethane foam inside	

Convertible® I-SERIES CHAIR

LIMITED WARRANTY

PLEASE NOTE: THE WARRANTY BELOW HAS BEEN DRAFTED TO COMPLY WITH FEDERAL LAW APPLICABLE TO PRODUCTS MANUFACTURED AFTER JULY 4, 1975.

This warranty is extended only to the original purchaser/user of our products.

This warranty gives you specific legal rights and you may also have other legal rights, which vary from state to state.

Barton Medical warrants the chair frame to be free from defects in materials and workmanship for a period of three (3) years from date of purchase. Wear items including, but not limited to: upholstery, casters, locking cylinder, release cable, recline release handle, guide rod wear strips, and seat frame wear collars are warranted to be free of defects in material and workmanship for a period of one (1) year. If within such warranty period any such products shall be proven to be defective, such product shall be repaired or replaced, at Barton Medical's option. This warranty does not include any labor or shipping charges incurred in replacement part installation or repair of any such product. Barton Medical's sole obligation and your exclusive remedy under this warranty shall be limited to such repair and/or replacement.

For warranty service, please contact Barton Medical. Do not return products without our prior consent.

LIMITATIONS AND EXCLUSIONS: The foregoing warranty shall not apply to:

- Serial numbered products if the serial number has been removed or defaced;
- Products subjected to negligence, accident, improper operation, maintenance, or storage;
- Products modified without Barton Medical's express written consent including, but not limited to, modification through the use of unauthorized parts or attachments; Products damaged by reason of repairs made to any component without the specific consent of Barton Medical; or to
- Products damaged by circumstances beyond Barton Medical's control.

Such evaluation will be solely determined by Barton Medical. The warranty shall not apply to problems arising from normal wear or failure to adhere to these instructions.

THE FOREGOING WARRANTY IS EXCLUSIVE AND IN LIEU OF ALL OTHER EXPRESS WARRANTIES. IMPLIED WARRANTIES, IF ANY, INCLUDING THE IMPLIED WARRANTIES OF MERCHANTABILITY AND FITNESS FOR A PARTICULAR PURPOSE, SHALL NOT EXTEND BEYOND THE DURATION OF THE EXPRESSED WARRANTY PROVIDED HEREIN AND THE REMEDY FOR VIOLATIONS OF ANY IMPLIED WARRANTY SHALL BE LIMITED TO REPAIR OR REPLACEMENT OF THE DEFECTIVE PRODUCT PURSUANT TO THE TERMS CONTAINED HEREIN. BARTON MEDICAL SHALL NOT BE LIABLE FOR ANY CONSEQUENTIAL OR INCIDENTAL DAMAGES WHATSOEVER.

THIS WARRANTY SHALL BE EXTENDED TO COMPLY WITH STATE/PROVINCIAL LAWS AND REQUIREMENTS.



SWEDEN

Årstaängsvägen 21C

Phone:- +46 8 665 35 00

Fax:- +46 8 665 35 10

E-mail: info.se@humancaregroup.com